

**OWNER'S MANUAL**  
**MODEL NO.**  
**16604003500**  
**FSX3500**



- *Assembly*
- *Operation*
- *Trouble –Shooting*
- *Parts*
- *Warranty*



**CAUTION:**

*You must read and understand this owner's manual before operating unit.*

*Keep this manual for future reference.  
Serial number*

*Write the serial number in the space above for reference. Serial number can be found at the front bottom section of the elliptical.*



# Manufacture's Limited Warranty

Dyaco Canada Inc. warrants all its home use elliptical parts for a period of time listed below, from the date of retail sale, as determined by a sales receipt. Dyaco Canada Inc.'s responsibilities include providing new or remanufactured parts, at Dyaco Canada Inc.'s option, and technical support to our independent dealers and servicing organizations. In the absence of a dealer or service organization, these warranties will be administered by Dyaco Canada Inc. directly to a consumer. The warranty period applies to the following components:

## Home Use Limited Warranty

Frame	Lifetime
All Other Components	2 Years
Labour	1 Year

This warranty is not transferable and is extended only to the original owner.

The warranty shall not apply to exercise units which are (1) used for commercial or other income producing purposes, or (2) subject to misuse, neglect, accident or unauthorized repair and alterations.

This warranty provided herein is lieu of all other express warranties, any implied warranties, including any implied warranties of merchantability of fitness for particular purpose, are limited in duration to the first 12 months from date of purchase. All other obligations or liabilities, including liability for consequential damages are hereby excluded.

## REPAIR PARTS AND SERVICE

All of the parts for the elliptical shown in figure can be ordered from Dyaco Canada Inc. 5955 Don Murie Street, Niagara Falls, Ontario L2G 0A9. When ordering parts, the parts will be sent and billed at the current prices. Prices may be subject to change without notice. Money order or credit card payment must accompany all orders. Standard hardware items are available at your local hardware store.

To ensure prompt and correct handling of any errors, or to answer any questions, please call our Toll Free number: 1-888-707-1880, or local number 1-905-353-8955 or fax 1-905-353-8968 or email [customerservice@dyaco.ca](mailto:customerservice@dyaco.ca). You can visit us at [www.dyaco.ca](http://www.dyaco.ca). Office hours are from 8:30 AM to 5:00 PM Monday to Friday Eastern Standard Time.

Always include the following information when ordering parts

- Model number
- Name of each part
- Part number of each part

## TABLE OF CONTENTS

WARRANTY	2	OPERATION OF YOUR CONSOLE	14-25
IMPORTANT SAFETY INFORMATION	3-4	DIAGRAM	28
IMPORTANT SAFETY INSTRUCTIONS	5	PARTS LIST	29-31
HOW THE ELLIPTICAL WORKS	6	USER DIRECTION	32-33
ASSEMBLY PACK CHECKLIST	8-9	TRAINING GUIDELINE	34-37
ASSEMBLY INSTRUCTION	10-13	STRETCHING	38-39

# IMPORTANT SAFETY INFORMATION

**THIS UNIT IS INTENDED FOR HOUSEHOLD USE ONLY  
READ ALL INSTRUCTIONS BEFORE USING THIS ELLIPTICAL**

Thank you for purchasing our product. Even though we go to great efforts to ensure the quality of each product we produce, occasional errors and /or omissions do occur. In any event should you find this product to have either a defective or a missing part please contact us for a replacement.

This product has been designed for home use only. Product liability and guarantee conditions will not be applicable to products being subjected to professional use or products being used in a gym center.

This exercise equipment was designed and built for optimum safety. However, certain precautions apply whenever you operate a piece of exercise equipment. Be sure to read the entire manual before assembly and operation of this machine. Also, please note the following safety precautions:



## WARNING

It is the responsibility of the owner to ensure that all users of this elliptical are adequately informed of all warnings and precautions. Read the OWNER'S OPERATING MANUAL and all warnings posted on the elliptical and follow it carefully before using your elliptical.

Review all warnings labels that affixed to the elliptical. Inspect your exercise equipment prior to exercising to ensure that all nuts and bolts are fully tightened before each use. Functional and Visual inspection of the equipment shall be made after assembling your elliptical

1. Never operate the elliptical if it is not working properly, if it has been dropped, damaged, or exposed to water.
2. Set up and operate the elliptical on a solid level surface. Do not use outdoors or near water. Do not place the unit on a loose rug or uneven surface. It is recommended to use an equipment mat to prevent the unit from moving while it is being used, which could possibly scratch or damage the surface of your floor. It is recommended to have a minimum of 3 metres safe clearance on all sides of the elliptical while in use.
3. Keep the elliptical indoors, away from moisture and dust. Do not put the elliptical in a garage, covered patio or near water.
4. Do not operate the elliptical where aerosol products are used or where oxygen is being administered.
5. Do not insert any objects into any openings.
6. Inspect and properly tighten all parts of the elliptical regularly.
7. Keep children and pets away from this equipment at all times and while exercising.
8. Handicapped individuals should have medical approval and close supervision when using this elliptical.
9. Do not place hands or feet under the elliptical. Always keep hands and legs off of the elliptical when others are using it.
10. Always hold the handlebars when mounting, dismounting, or using the elliptical. Keep your back straight when using your elliptical, do not arch your back. When you stop exercising, allow the pedals to slowly come to a complete stop.
11. To disconnect, turn all controls to the off position, then remove plug from outlet.
12. Use the elliptical only for its intended use as described in this manual. Do not use any attachments that are not recommended by the manufacturer.
13. User weight should not exceed 331lbs (130 kgs).
14. Never allow more than one person on the elliptical at once.
15. Warm up 5 to 10 minutes before each workout and cool down 5 to 10 minutes afterward. This allows your heart rate to gradually increase and decrease and will help prevent straining muscles.

16. Never hold your breath while exercising. Breathing should remain at a normal rate in conjunction with the level of exercise being performed. If dizziness, nausea, chest pains, or any other abnormal symptoms are experienced while using this equipment, STOP the workout at once. CONSULT A PHYSICIAN IMMEDIATELY.
17. The pulse sensor is not a medical device. Various factors, including the user's movement, may affect the accuracy of heart rate readings. The pulse sensor is intended only as an exercise aid in determining heart rate trends in general.
18. Start your program slowly and very gradually increase your resistance.
19. Always wear suitable clothing and footwear while exercising. Do not wear loose fitting clothing that could become entangled with the moving parts of your elliptical.
20. Always hold on to a handlebar while making control changes.
21. Use caution while participating in other activities while using your elliptical such as watching television, reading, etc. These distractions may cause you to lose balance, resulting in serious injury.
22. The decal shown below has been placed on the elliptical. If the decal is missing or illegible, please call our Customer Service Department toll-free at 1-888-707-1880 to order a replacement decal. Apply the decal in the location shown.



▲ WARNING / AVERTISSEMENT
<b>XTERRA</b> Model/Modèle#: 16604003500 (PR: 0217) Serial#/Numéro de série: <b>123456789</b>
<b>For consumer use.</b> <b>Max user weight limit</b> <b>331lbs. (150kgs)</b> CAUTION: SMALL CHILDREN AND PERSONS PHYSICALLY HANDICAPPED SHOULD NOT USE ANY EXERCISE EQUIPMENT WITHOUT A QUALIFIED PERSON IN ATTENDANCE. WARNING: KEEP CHILDREN AWAY FROM THE ELLIPTICAL. KEEP BODY AND CLOTHING FREE AND CLEAR OF ALL MOVING PARTS THE POSSIBILITY OF SERIOUS INJURIES OR DEATH IF CAUTION IS NOT USED. READ ALL WARNINGS AND INSTRUCTIONS PRIOR TO USE. REPLACE LABEL IF DAMAGED, ILLEGIBLE OR REMOVED. <b>MADE IN TAIWAN</b>
<b>Usage à des fins</b> <b>personnelles.</b> <b>poids maximum de l'utilisateur</b> <b>331lbs (150kgs)</b> ATTENTION: LES ENFANTS ET LES PERSONNES AYANT UN HANDICAP PHYSIQUE NE DOIVENT UTILISER AUCUN APPAREIL D'EXERCICE SANS LA SURVEILLANCE D'UNE PERSONNE QUALIFIÉE. AVERTISSEMENT: GARDER LES ENFANTS À L'ÉCART DE L'APPAREIL ELLIPTIQUE GARDER LE CORPS ET LES VÊTEMENTS ÉLOIGNÉS DE TOUTE PIÈCE MOBILE. LE DÉFAUT DE VIGILANCE DANS L'UTILISATION DE CET APPAREIL POURRAIT ENTRAÎNER DE GRAVES BLESSURES ET MÊME LA MORT. LIRE TOUTS LES AVERTISSEMENTS ET TOUTES LES DIRECTIVES AVANT UTILISATION. REMPLACER TOUTE ÉTIQUETTE ENDOMMAGÉE, ILLISIBLE OU MANQUANTE. <b>FABRIQUÉ À TAIWAN</b>
<b>Dyaco Canada Inc.</b> 5955 Don Murie St Niagara Falls, ON L2G 0A9 Customer Service Service à la clientèle 1-888-707-1880

**WARNING:** Before beginning any exercise program consult your physician. This is especially important for individuals over the age of 35 or persons with pre-existing health problems. Read all instructions before using any fitness equipment. We assume no responsibility from personal injury or property damage sustained by or through the use of this product.

## SAVE THESE INSTRUCTIONS

# IMPORTANT SAFETY INSTRUCTIONS

When using this equipment, basic precautions should always be followed, including the following: Read all instructions before using this elliptical.

**DANGER** - To reduce the risk of electric shock:

Always unplug the equipment from the electrical outlet immediately after using and before cleaning.



**WARNING** - To reduce the risk of burns, fire, electric shock, or injury to persons:

1. The elliptical should never be left unattended when plugged in. Unplug from outlet when not in use, and before repairing or cleaning.
  2. Never operate this elliptical if it has a damaged cord or plug, if it is not working properly, if it has been dropped or damaged, or dropped into water. Please contact our customer service if the elliptical requires service or repair.
  3. Do not carry this elliptical by the cord or use the cord as a handle.
  4. Keep the cord away from heated surfaces or flames.
  5. Never operate the elliptical with the air openings blocked. Keep the air openings free of lint, hair, and things alike.
  6. Connect this elliptical to a properly grounded outlet only.
  7. The use of an extension cord with this product is not recommended. If an extension cord is needed, use a short (less than 10 feet) heavy gauge (14 gauge or better) extension cord with a three prong (grounded) plug and receptacle.
- **NEVER** remove any cover without first disconnecting AC power supply.
  - If A.C. voltage varies by ten percent (10%) or more, the performance of your elliptical may be affected. Such conditions are not covered under your warranty. If you suspect the voltage is low, contact your local power company or a licensed electrician for proper testing.
  - **NEVER** expose this elliptical to rain or moisture. This product is NOT designed for use outdoors, near a pool or spa, or in any other high humidity environment. Maximum environmental ratings are 40-120 degrees Fahrenheit, 95% humidity non-condensing (no water droplets forming on surfaces).
  - **NEVER** use your elliptical during an electrical storm. Surges may occur in your household power supply that could damage elliptical components.

Failure to follow all guidelines may compromise the effectiveness of the exercise experience, expose yourself (and possibly others) to injury, and reduce the longevity of the equipment.

**SAVE THESE INSTRUCTIONS - THINK SAFETY!**

# HOW THE ELLIPTICAL WORKS

The elliptical allows your feet to move in a natural elliptical path, minimizing the impact on your knees and ankles.

- Dual Action Handles for total body workout
- Stationary handlebar for stability

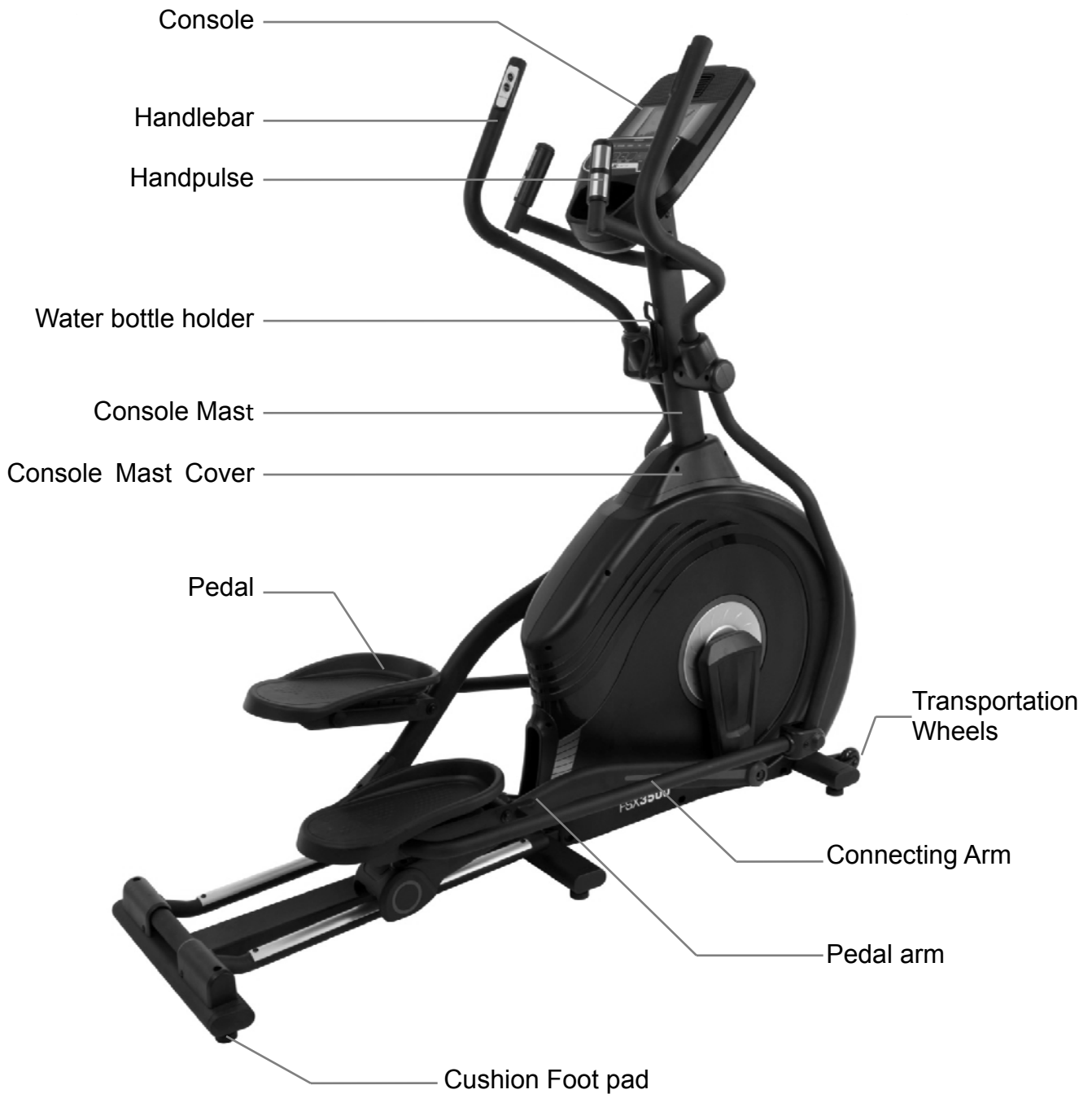

## Transportation

The elliptical is equipped with transport wheels, which are engaged when the rear of the elliptical is lifted.

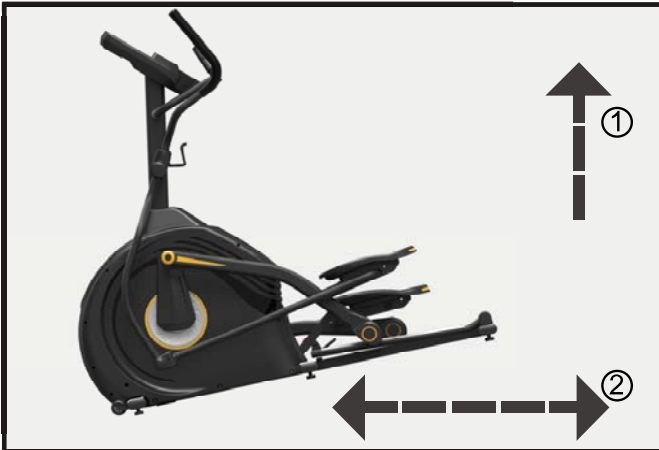

**POWER CONNECTOR – FRONT, LEFT SIDE OF UNIT**

## Elliptical Lubrication

1. Pour 2c.c of the lubricant under the middle of the rail. You must be lubricate the rails every three months.
2. If you feel the exercise is not smooth or you hear noise during your exercise, lubricate the middle rail with 2 c.c.of the lubricant.





# Assembly Pack Checklist

## Hardware Step 1

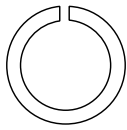

**#136.** 3/8" × 2T  
Spring Washer (4 pcs)

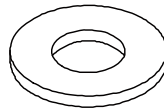

**#133.** 3/8" × 19 × 1.5T  
Flat Washer (4 pcs)

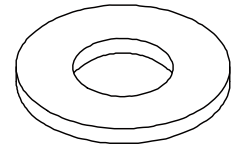

**#132.** Ø8.5 × 26 × 2.0T  
Flat Washer (2 pcs)

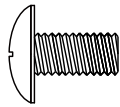

**#111.** M5 × 10m/m  
Phillips Head Screw (4 pcs)

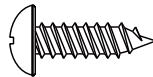

**#114.** Ø3.5 × 12m/m  
Sheet Metal Screw (2 pcs)

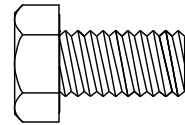

**#99.** 5/16" × 15m/m  
Hex Head Bolt (2 pcs)

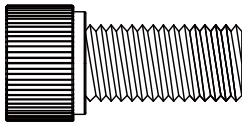

**#109.** 3/8" × 3/4"  
Socket Head Cap Bolt (4 pcs)

## Hardware Step 2



**#120.** 5/16" × 7T  
Nyloc Nut (6 pcs)

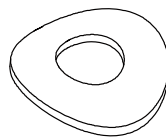

**#135.** 5/16" × 19 × 1.5T  
Curved Washer (4 pcs)

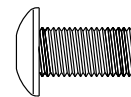

**#111.** M5 × 10m/m  
Phillips Head Screw  
(10 pcs)

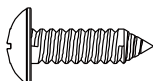

**#114.** Ø3.5 × 12m/m  
Sheet Metal Screw (4 pcs)

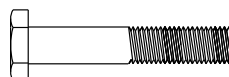

**#101.** 5/16" × 1-3/4"  
Hex Head Bolt (6 pcs)

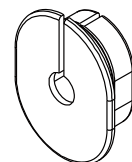

**#84.** Switch Wire Cap  
(2 pcs)



# Assembly Tools

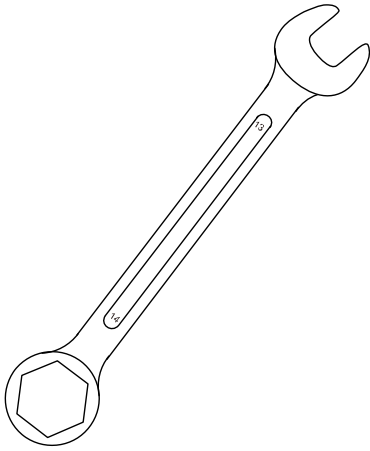

**#145.** 13/14m/m\_Wrench

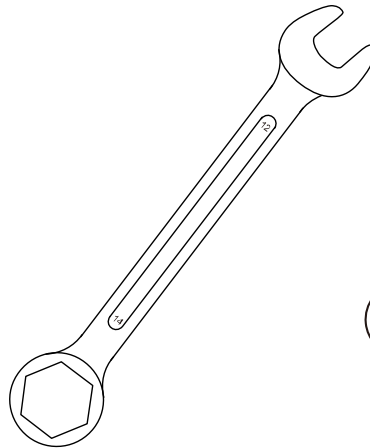

**#146.** 12/14m/m\_Wrench

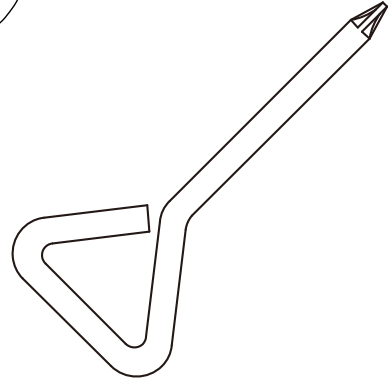

**#150.** Short Phillips Head Screwdriver

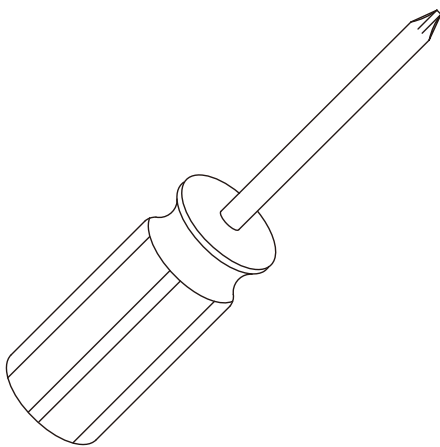

**#147.** Phillips Head Screwdriver

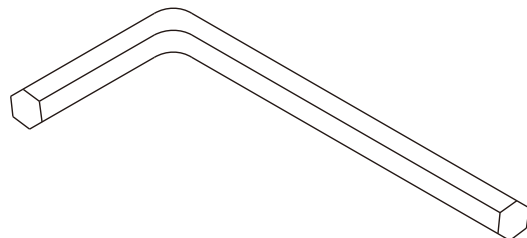

**#148.** L Allen Wrench

# Assembly Instructions

## 1-1 Console Mast

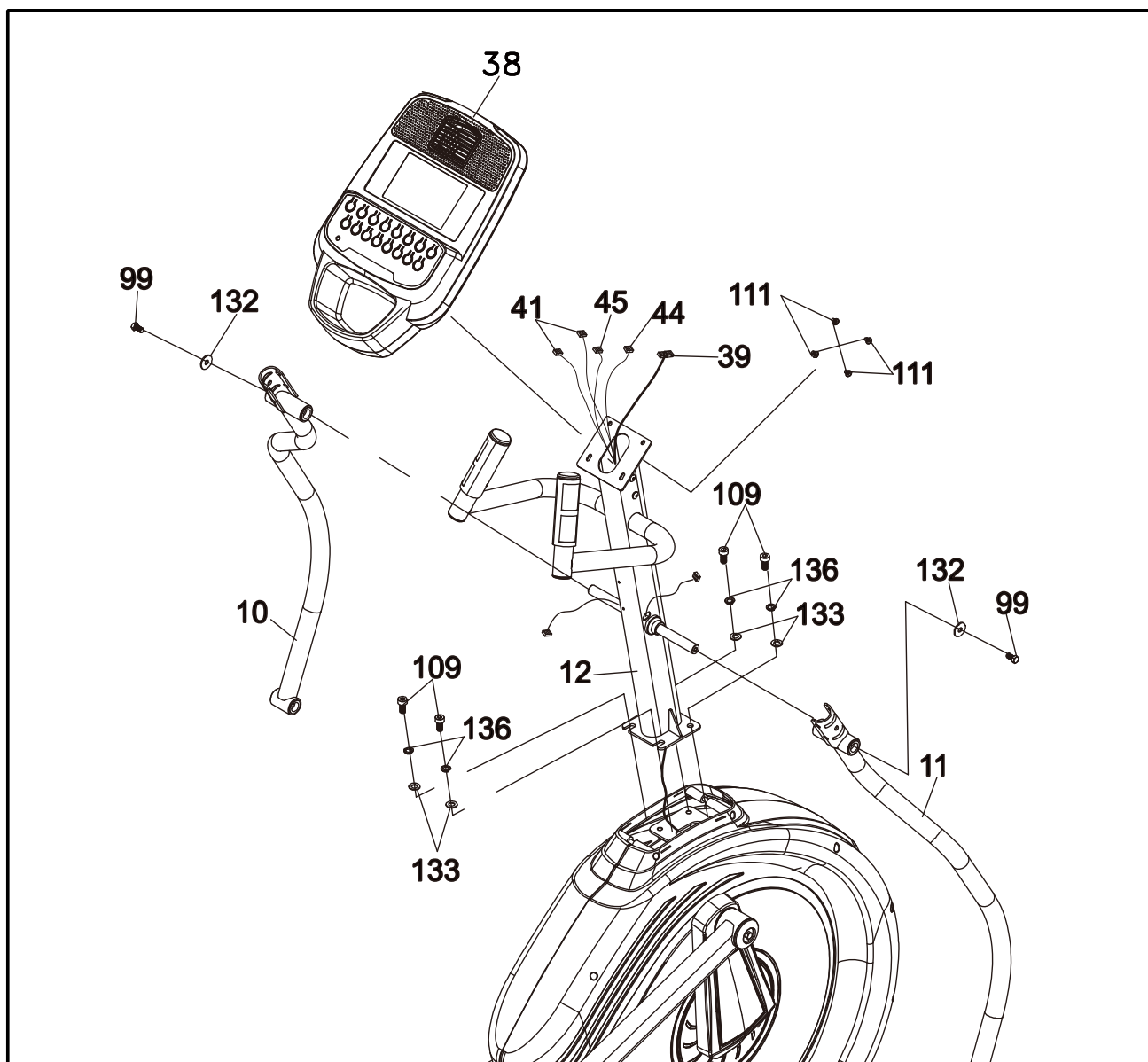

1. Pull the tie on Console Mast (12) to have Computer Cable (39) go through the mast from bottom and out of the mast on top. Secure the Console Mast on the mounting plate on the Main Frame with four 3/8" x 3/4" Socket Head Cap Bolts (109), four Ø3/8" x 2T Spring Washers (136) and four Ø3/8" x Ø19 x 1.5T Flat Washers (133) by using L Allen Wrench (148).
2. Plug all of the connectors into the back of the console (38); Computer Cable (39), two Hand pulse Cables (41), Resistance switch wire (44) and Incline switch wire (45). Secure the Console (38) on the console mounting plate with four Phillips Head Screws (111). (Be sure to not crush or damage wiring during process)
3. Place left and right Lower Handlebars (10) (11) onto left side and right side of Console mast shafts, respectively and secure with Hex Head Bolts (99) together with Flat Washers (132) by using Wrench (146).

## 1-2 Connecting Arm & Lower Handlebar

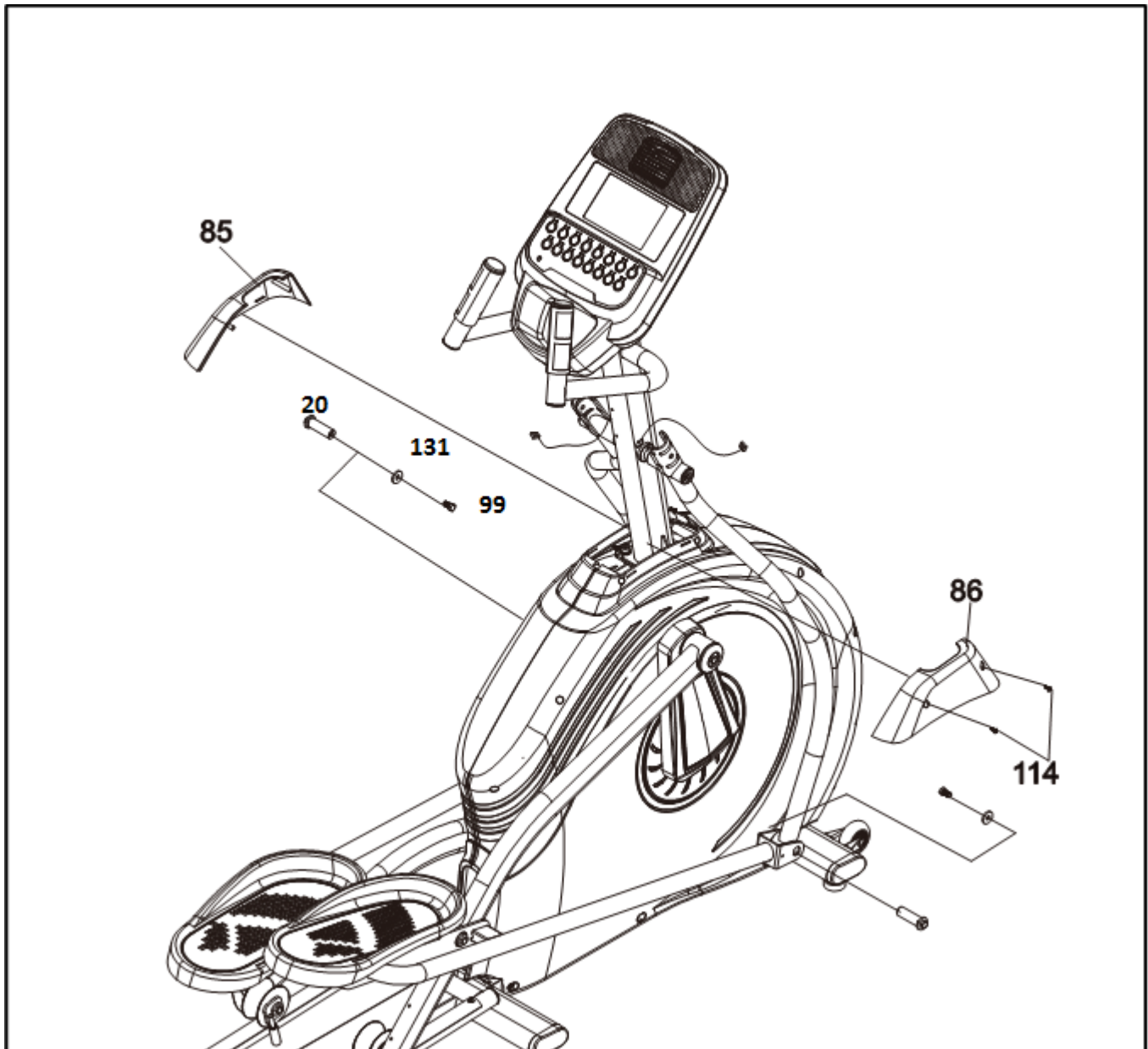

1. Release Axles (20), which are on left and right Connecting Arms (8.9). Connect the left and right Connecting Arms (8.9) with left and right Lower Handlebar (10.11) and secure with Axles (20), Hex Head bolts (99) and Flat Washers (131) by using 12/14m/m\_Wrench (146).
2. Bring the Left Upright Cover (85) and Right Upright Cover (86) together on the Side Case (L.R) and Console Mast and secure using two Sheet Metal Screws (114) and a Screwdriver (147).

## 2-1 Left Handlebar

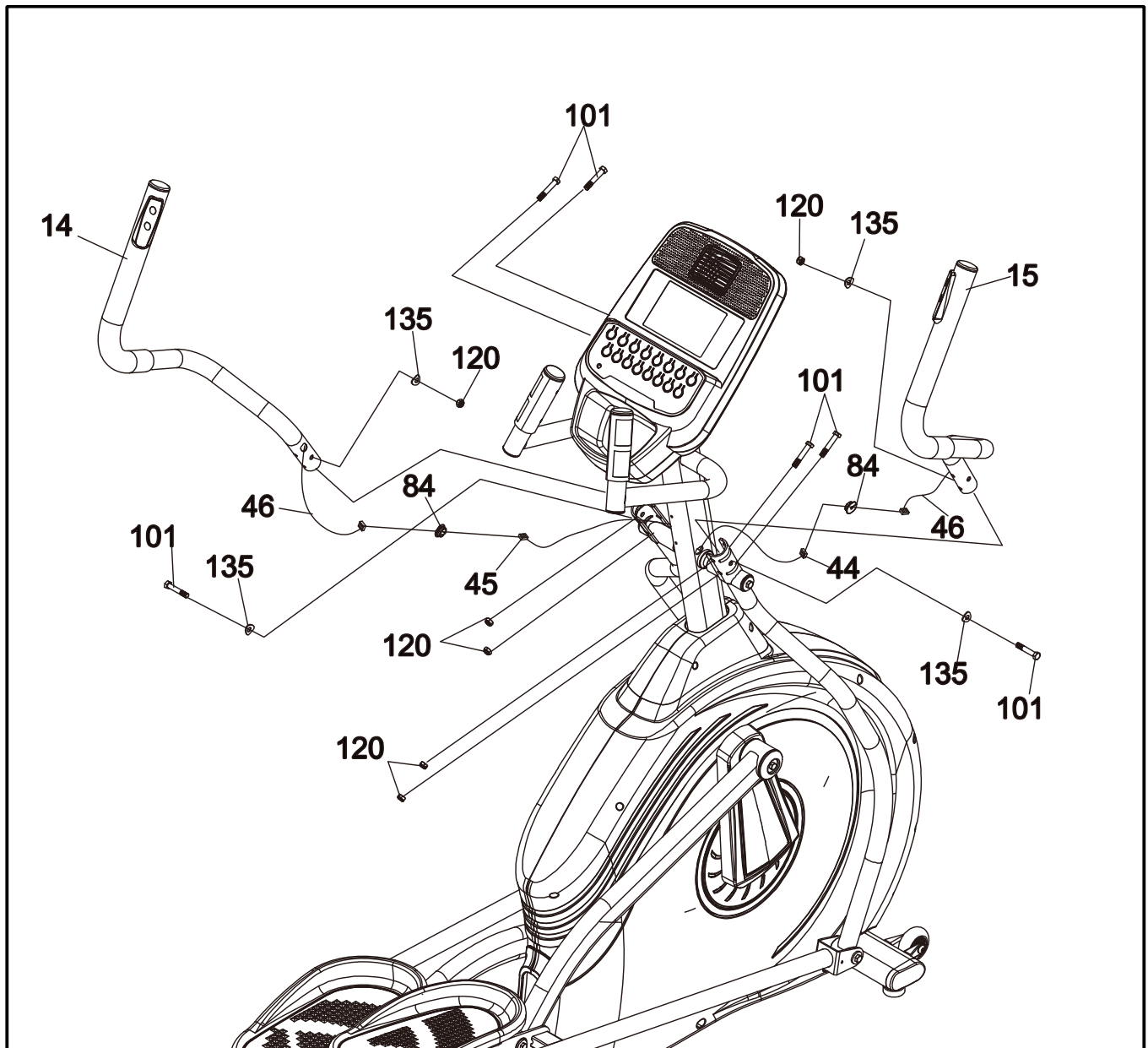

1. Insert left Handlebar (14) onto left Lower Handlebar and secure with three Hex Head Bolts (101), two Curved Washers (135) and three Nyloc Nuts (120) by using Wrench (146/145). Same way to secure right Handlebar (15) on right Lower Handlebar.
2. Connect Upper Resistance Handle Wire (44) with Lower Resistance/Incline Switch Cable (46) and store it in the frame tube and snap in Switch Wire Cap (84) on the console mast. Again, connect Upper Incline Handle Wire (45) with Lower Resistance/Incline Switch Cable (46) and store it in the frame tube. Snap in Switch Wire Cap (84) on the console mast.

## 2-2 Plastic Covers

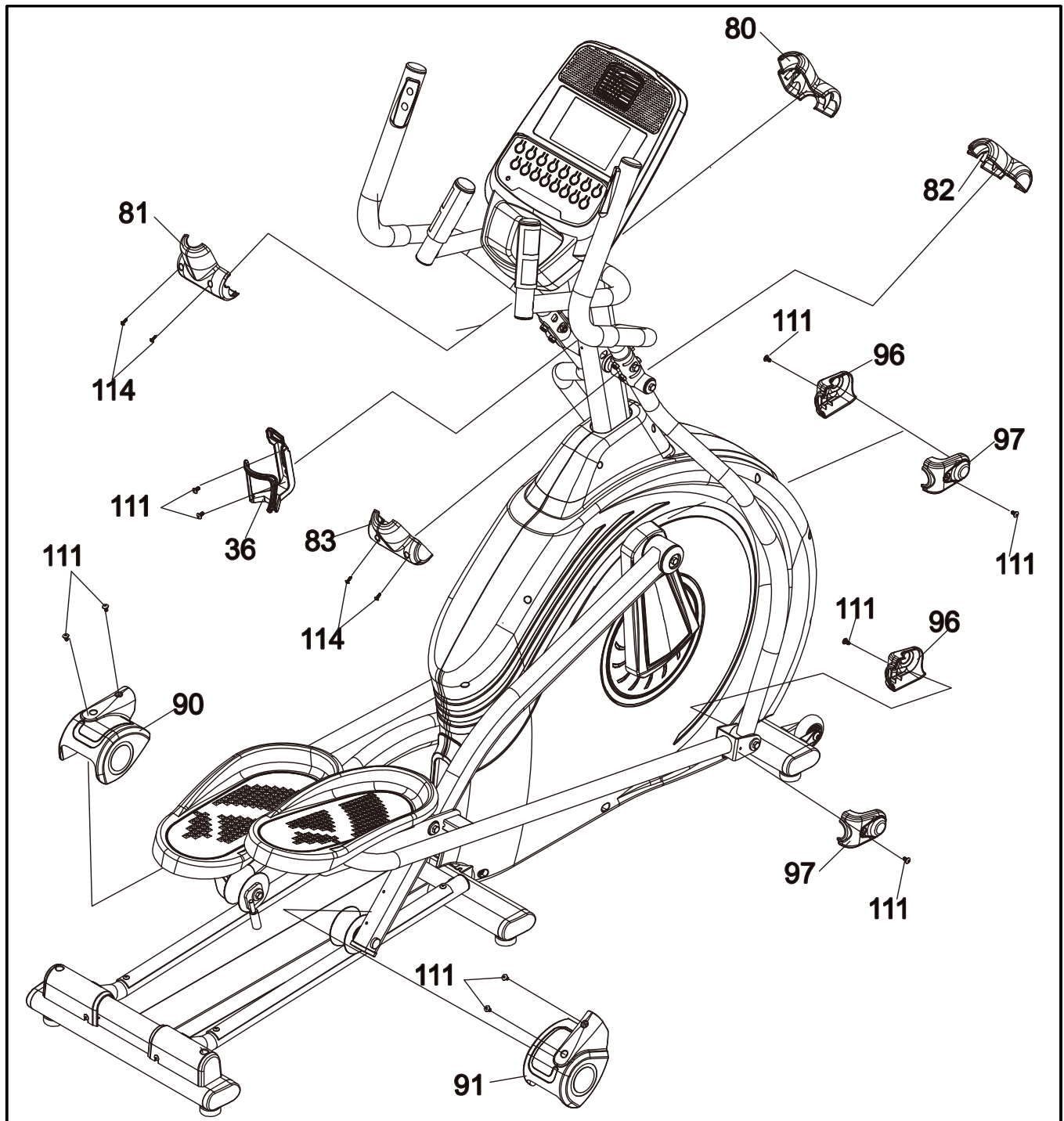

1. Match right and left Connecting Arm Covers (97, 96) on left Connecting Arm and fix with two Phillips Head Screws (111) by using Phillips Head Screwdriver (147). Fix right and left Connecting Arm Covers (97, 96) on right Connecting Arm with the same way and hardware.
2. Install Sliding Wheel Covers (90, 91) on each side and secure with four Phillips Head Screws (111).
3. Install the Handle Covers (80 & 81, 82 & 83) over the Handle Bar axle connections and secure with the four Sheet Metal Screws (114).
4. Use Phillips Head Screwdriver to secure the Drink Bottle Holder (36) on the console mast with two Phillips head screws (111).

# Operation of Your Console



## Console

### Power up :

This model requires AC 110V power supply. Connect the power cable to the socket on the left side of the machine near the front and turn on the switch. When user turn on the switch, console will be turned on, and have a long beep sound with LCD full display for 2 seconds. Then it display the version for 3 seconds, and enter to the USER mode.

### Functions :

1. MANUAL : Setting workout by manual, include target value setting of TIME, CAL, DIST, PULSE.
2. PROGRAM : P1~P18, 18 program profiles can be selected.
3. FAT BURN : Preset fat burning workout program
4. CARDIO : Preset oxygen sport workout program
5. HILL : Preset Hill workout program
6. INTERVAL : Preset Interval workout program
7. HRC : The load is controlled by the heart rate automatic, there are 6 options 50%, 60%, 70%, 80%, 90%, and TARGET.
8. USER DEFINE : User can set program profile by self.



## Button Functions :

1. START : Start workout
2. STOP : Workout pause, and press again back to standby mode. Press and hold the button, console will restart.
3. ENTER : Confirm the function or setting value, switch LEVEL / INCLINE display (grade mode)
4. LEVEL + : Increase the load or upward the setting value such as TIME.
5. LEVEL - : Decrease the load of downward the setting value such as TIME.
6. INCLINE + : Upward the incline
7. INCLINE - : Downward the incline
8. FAN : Fan function ON/OFF
9. MANUAL : In the standby mode, press MANUAL quick key into MANUAL mode.
10. PROGRAM : In the standby mode, press PROGRAM quick key into PROGRAM mode.
11. FAT BURN : In the standby mode, press FAT BURN quick key into FAT BURN mode.
12. CARDIO : In the standby mode, press CARDIO quick key into CARDIO mode.
13. HILL : In the standby mode, press HILL quick key into HILL mode.
14. INTERVAL : In the standby mode, press INTERVAL quick key into INTERVAL mode.
15. HRC : In the standby mode, press HRC quick key into HRC mode.
16. USER DEFINE : In the standby mode, press USER quick key into USER DEFINE mode.

## Operation :

1. Console power on with beep sound, and LCD full display for 2 seconds(image 1), then showing the version and model for 3 seconds. After that, enter USER data setting. There are 2 sets of USER data setting, press 【LEVEL +/LEVEL - 】 to select, and press 【ENTER】 to confirm. Setting process : USER→AGE→WEIGHT(image 2~image 4);After setting, enter to the standby mode.(image 5).

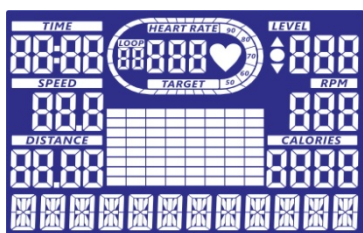

image 1

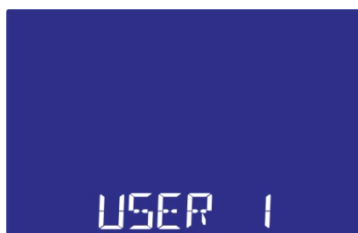

image 2



image 3



image 4



image 5



2. In the standby mode, press **【START】** to QUICK START, and enter Manual mode to start workout. Or, press **【LEVEL+ /LEVEL-】** to select Manual , Program , Fat burn , Cardio , Hill , Interval , HRC and User define (image 6~image 13), then press **【ENTER】** to confirm. Or, directly press fuction Quick key to quick enter.

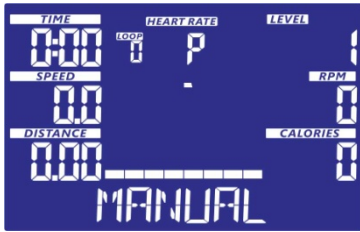

image 6

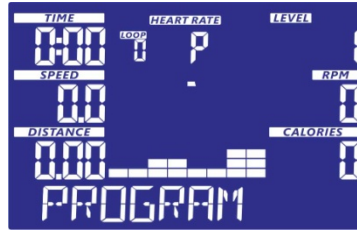

image 7

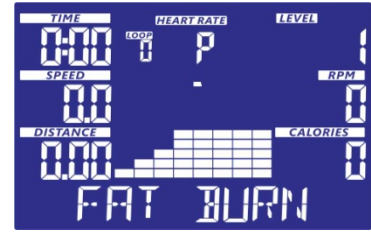

image 8

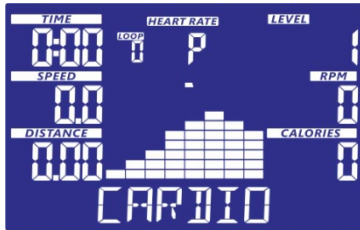

image 9

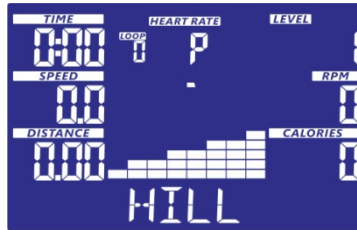

image 10

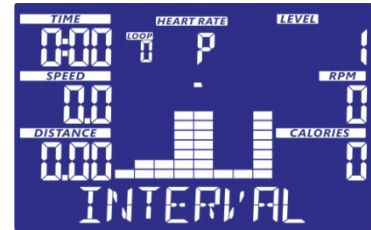

image 11



image 12

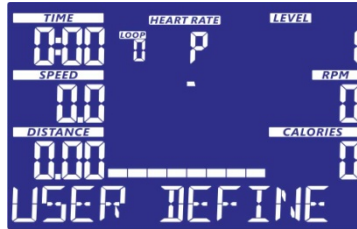

image 13

3. Manual mode : In standby mode, press **【LEVEL+ /LEVEL-】** to select MANUAL, and press **【ENTER】** . Or, press **【MANUAL】** quick key to enter this mode directly. Then, set the target value in sequence TIME →DISTANCE → CALORIES → HEART RATE(image 14~image 17) by pressing **【LEVEL+ /LEVEL-】** to adjust, and press **【ENTER】** into next value setting. After setting, press **【START】** to start workout, and press **【LEVEL+ /LEVEL-】** to adjust the load during workout. Press **【INCLINE+ / INCLINE-】** to adjust incline, press **【STOP】** to pause workout, and press **【STOP】** again back to the standby mode. One of TIME, DISTANCE, and CALORIES preset target value count down to zero, the workout will be stopped, all the values stop counting. Press **【STOP】** to leave this mode and return to standby mode.



image 14



image 15



image 16



image 17

- Program mode : In standby mode, press **【LEVEL +/LEVEL -】** to select PROGRAM, and press **【ENTER】** . Or, press **【P】** quick key to enter this mode directly. First, select program profiles (image 18) total 18 sets. Press **【ENTER】** to confirm the profiles, and set target TIME (image 19) by pressing **【LEVEL +/LEVEL -】** to adjust. After setting, press **【START】** to start workout, and press **【LEVEL +/LEVEL -】** to adjust the load during workout. Press **【INCLINE +/ INCLINE -】** to adjust incline, press **【ENTER】** to switch LEVEL / INCLINE display, press **【STOP】** to pause workout, and press **【STOP】** again back to the standby mode. When preset the target TIME, the target value count down to zero, the workout will be stopped, and all the values stop counting. Press **【STOP】** to leave this mode and return to standby mode.

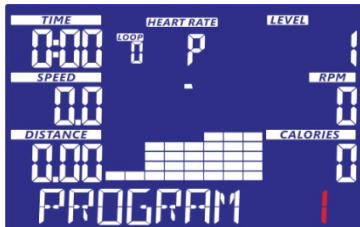

image 18

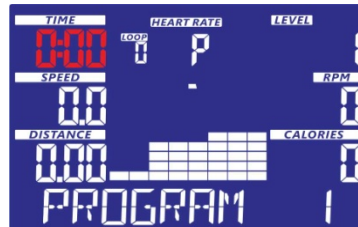

image 19

- Fat Burn mode : In standby mode, press **【LEVEL +/LEVEL -】** to select FAT BURN, and press **【ENTER】**. Or, press **【FAT BURN】** quick key to enter this mode directly. Then, set target TIME (image 20) by pressing **【LEVEL +/LEVEL -】** to adjust. After setting, press **【START】** to start workout, and press **【LEVEL +/LEVEL -】** to adjust the load during workout. Press **【INCLINE +/ INCLINE -】** to adjust incline, press **【ENTER】** to switch LEVEL / INCLINE display, press **【STOP】** to pause workout, and press **【STOP】** again back to the standby mode. When preset the target TIME, the target value count down to zero, the workout will be stopped, and all the values stop counting. Press **【STOP】** to leave this mode and return to standby mode.

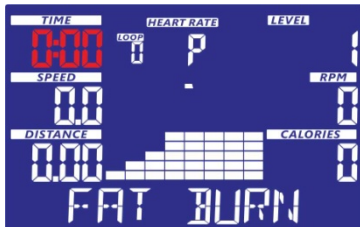

image 20

- Cardio mode : In standby mode, press **【LEVEL +/LEVEL -】** to select CARDIO, and press **【ENTER】**. Or, press **【CARDIO】** quick key to enter this mode directly. Then, set target TIME (image 21) by pressing **【LEVEL +/LEVEL -】** to adjust. After setting, press **【START】** to start workout, and press **【LEVEL +/LEVEL -】** to adjust the load during workout. Press **【INCLINE +/ INCLINE -】** to adjust incline, press **【ENTER】** to switch LEVEL / INCLINE display, press **【STOP】** to pause workout, and press **【STOP】** again back to the standby mode. When preset the target TIME, the target value count down to zero, the workout will be stopped, and all the values stop counting. Press **【STOP】** to leave this mode and return to standby mode.



image 21

7. Hill mode : In standby mode, press **【LEVEL +/LEVEL -】** to select HILL, and press **【ENTER】**. Or, press **【HILL】** quick key to enter this mode directly. Then, set target TIME (image 22) by pressing **【LEVEL +/LEVEL -】** to adjust. After setting, press **【START】** to start workout, and press **【LEVEL +/LEVEL -】** to adjust the load during workout. Press **【INCLINE +/ INCLINE -】** to adjust incline, press **【ENTER】** to switch LEVEL / INCLINE display, press **【STOP】** to pause workout, and press **【STOP】** again back to the standby mode. When preset the target TIME, the target value count down to zero, the workout will be stopped, and all the values stop counting. Press **【STOP】** to leave this mode and return to standby mode.

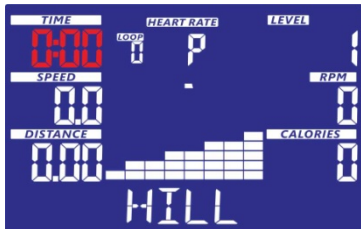

image 22

8. Interval mode : In standby mode, press **【LEVEL +/LEVEL -】** to select INTERVAL, and press **【ENTER】**. Or, press **【INTERVAL】** quick key to enter this mode directly. Then, set target TIME (image 23) by pressing **【LEVEL +/LEVEL -】** to adjust. After setting, press **【START】** to start workout, and press **【LEVEL +/LEVEL -】** to adjust the load during workout. Press **【INCLINE +/ INCLINE -】** to adjust incline, press **【ENTER】** to switch LEVEL / INCLINE display, press **【STOP】** to pause workout, and press **【STOP】** again back to the standby mode. When preset the target TIME, the target value count down to zero, the workout will be stopped, and all the values stop counting. Press **【STOP】** to leave this mode and return to standby mode.

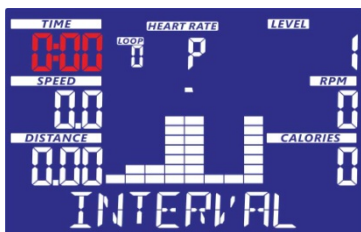

image 23

9. HRC mode : In standby mode, press **【LEVEL + / LEVEL -】** to select HRC, and press **【ENTER】** .Or, press **【HRC】** quick key to enter this mode directly. First, select HRC 50%, 60%, 70%, 80%, 90%, or TARGET HRC (image 24~image 29) total 6 sets. TARGET HRC is able to set the target pulse value. After entering to the TARGET HRC, you need to set the target pulse value (image 30), and press **【ENTER】** to confirm, then enter to the target Time setting (image 31). When you select HRC % and press **【ENTER】** , it will enter to target TIME setting directly (image 31), except TARGET HRC. After setting, press **【START】** to start workout, and press **【INCLINE + / INCLINE -】** to adjust incline during workout. The load will automatically change according to the pulse and cannot be adjusted manually. Therefore, the console need to keep receiving pulse signal in this mode. Press **【STOP】** to pause workout, and press **【STOP】** again back to the standby mode. When preset the target TIME, the target value count down to zero, the workout will be stopped, and all the values stop counting. Press **【STOP】** to leave this mode and return to standby mode. If there is no pulse signal during workout, the console will show “CHECK PULSE”(image 32), and after 1 minute, it will be back to standby mode. If the current pulse is over target pulse, the console will have beep sound as warning signal. Keep having warning sound 30 seconds, the workout will be stopped, and all the values stop counting. Press **【STOP】** to leave this mode and return to standby mode.

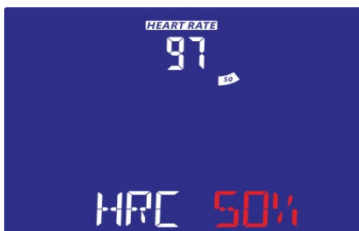

image 24



image 25

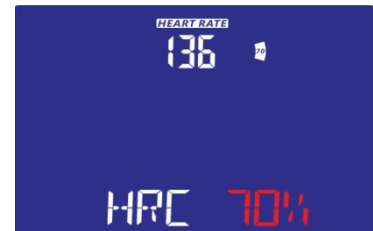

image 26

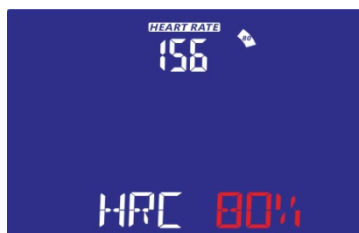

image 27

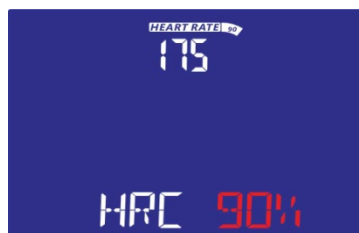

image 28



image 29

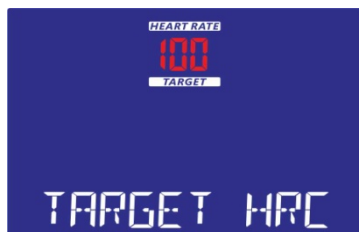

image 30



image 31

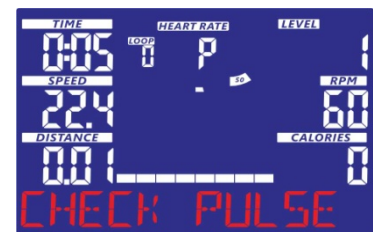

image 32

10. User Define mode : In standby mode, press **【LEVEL +/LEVEL –】** to select USER DEFINE, and press **【ENTER】**. Or, press **【INTERVAL】** quick key to enter this mode directly. User may press **【LEVEL +/LEVEL –】** and then press **【ENTER】** to create his own profile from column 1 to column 20 (image 33). The heart rate window will display the number of rows, and the load window will display the load value for the current setting. After finishing the load value setting, press **【ENTER】** to set INCLINE value (image34). There are twenty rows of INCLINE setting. press **【LEVEL +/LEVEL –】** to set INCLINE value, and press **【ENTER】** again to set next row. The heart rate window will display the number of rows, and the load window will display the incline value for the current setting. After incline setting, press and hold **【ENTER】** to enter TIME setting (image 35). Then, set target TIME by pressing **【LEVEL +/LEVEL –】** to adjust. After that, press **【START】** to start workout, and press **【LEVEL +/LEVEL –】** to adjust the load during workout. Press **【INCLINE +/ INCLINE –】** to adjust incline, press **【STOP】** to pause workout, and press **【STOP】** again back to the standby mode. When preset the target TIME, the target value count down to zero, the workout will be stopped, and all the values stop counting. Press **【STOP】** to leave this mode and return to standby mode.



image 33

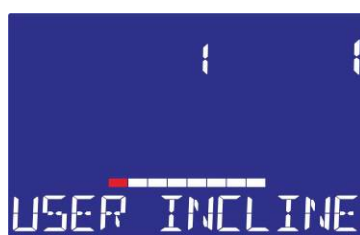

image 34

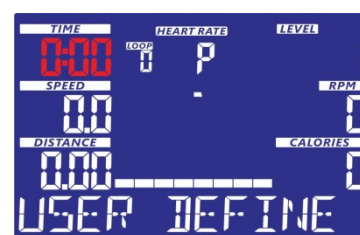

image 35

11. INCLINE calibration : In standby mode, press **【ENTER】** and **【INCLINE +】** for 2 seconds to enter the auto-calibration mode. (image 36) ◦



image 36

12. Factory Setting mode : In standby mode, press **【ENTER】** and **【LEVEL +】** for 2 seconds to enter factory setting mode. In this mode, press **【LEVEL +/LEVEL –】** to select, and press **【ENTER】** to the next setting. When the last option is set by press **【ENTER】**, or press **【STOP】** during setting, the setting value will be stored and restarted.

Option item :

1. UNIT(KM/ML) – Set to English or Metric display readings
2. BRIGHT(0~15) – Adjust backlight brightness
3. SPECIAL(YES/NO) – Pull wire motor for special drive action
4. MAX LOAD(16 20 24 32) – Set the maximum resistance value
5. UX DATA(ON/OFF) – 4 sets of user option switches
6. WHEEL(10~99) – Wheel setting
7. INCLINE LOAD(1~20) – Set the maximum Incline



# Note:

## 1. PROGRAM MOTION PROFILES 1~18

### PROGRAM 1, Muscle Endurance :

Muscle endurance is the ability of a muscle to maintain for a long time under load resistance. The muscular endurance program utilizes overload resistance training to allow the muscles to withstand high loads, stimulate physiological disturbances, and enhance muscle tissue adaptability, which is the most effective way to increase muscle endurance.

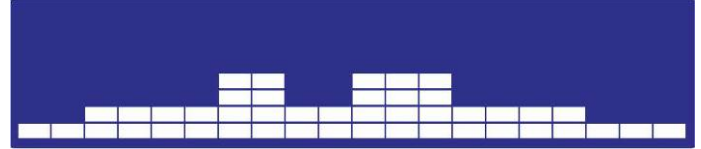

### PROGRAM 2, Core Muscles :

The core muscles must be continuously trained to maintain muscle strength. The core muscle program is able to maintain the consistency of exercise, and keep the body stable without shaking, so that the body can use each muscle more precisely.



### PROGRAM 3, Simulation :

Simulation is similar to the mountaineering method. The slopes encountered in the mountains are different, the resistance is stronger, and the training of the leg muscles is strengthened. The curve of the lower body and the body can be sculptured to achieve the effect of lifting the hips and sculpting.

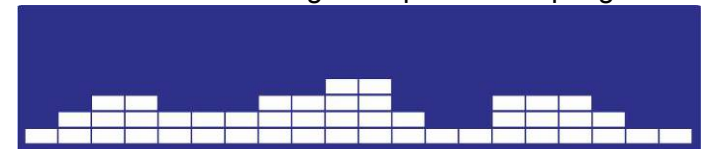

### PROGRAM 4, Aerobic Exercise :

The aerobic exercise program allows athletes to maintain a high number of strokes, allowing the user to achieve a maximum heart rate of 50% to 90% at the exercise center. Do aerobic metabolism to achieve the effect of fat loss.



### PROGRAM 5, Thrill Hill :

The Thrill Hill program combines a few types of workout in one, with variations of cardio and strength portions to give you a thrill.



### **PROGRAM 6, X-sport :**

The X-sport program is designed to increase muscular strength in your lower body with extreme resistance. This program will steadily increase in resistance to high level and then keeps you there. This is to enhance the design of your legs and hips.

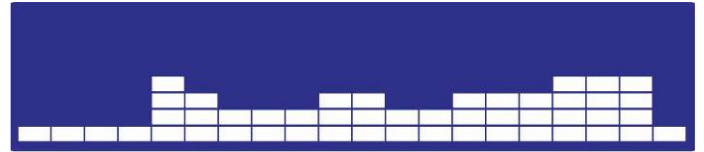

### **PROGRAM 7, Cardiopulmonary :**

The cardiopulmonary procedure is to strengthen the lungs and heart, allowing users to carry oxygen from the air and transport oxygen to tissue cells for use. Allows users to achieve a maximum heart rate of 60-80% during exercise, to reach a little breath but can also speak in a way to strengthen the heart and lung function.



### **PROGRAM 8, Off-road :**

Off-road program is simulated cross-country simulation. In the process, it will experience the climbing-like oppression and the downhill sense of pleasure. It will allow you to feel the smoothness and ease of use.



### **PROGRAM 9, Wild Ride :**

The Wild Ride program is designed to increase your cardio vascular function this is exercise for your heart and lungs. It will build up your heart muscle and increase blood flow and lung capacity. This is achieved by incorporating a higher level of exertion with slight fluctuations in work a real Wild Ride!



### **PROGRAM 10, Limit mode :**

Limit mode program is designed to exercise with continuous resistance to help the body increase fat consumption. This procedure stabilizes and gradually increases the resistance and maintains a constant intensity. This design is to strengthen and adapt your physical condition.





**PROGRAM 11, Low-intensity Training :**

The low-intensity training program is a comfortable speed. When you maintain this level of strength, it is not only easy to fatigue, but also allows users to spend more time training without any burden. Such training is very burdensome on the body and safe. The sex is high, and it is not easy to increase the lactic acid value in the blood, so it is suitable for mass sports.

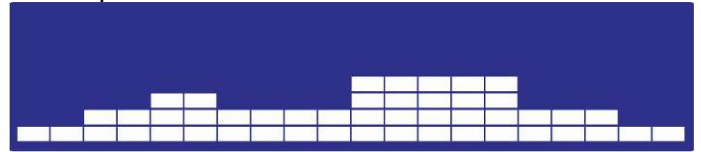
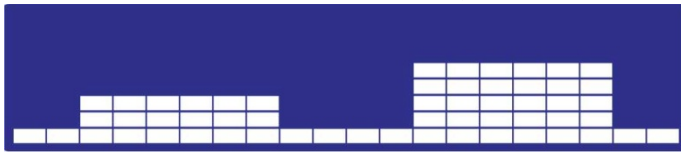

**PROGRAM 12, Canyons :**

The Canyons program takes you through high levels of intensity followed by periods of low intensity. This program increases your endurance by depleting your oxygen level followed by periods of recovery to replenish oxygen. Your cardio vascular system gets programmed to use oxygen more efficiently this way.



**PROGRAM 13, Resistance training :**

Using external 「resistance」 to train, the 「resistance」 generated by training equipment can achieve the effect of 「muscle contraction」, increase muscle strength and endurance, and promote aerobic fitness.

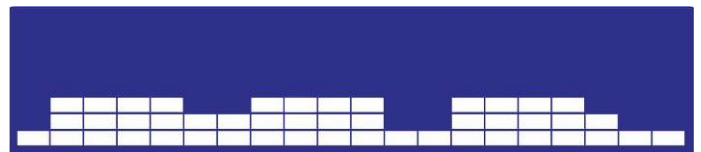

**PROGRAM 14, Conquering the uphill limit training :**

This is a good training for practicing leg muscle endurance. Speed is not the focus of this training. By gradually increasing the slope, the maximum muscle strength can be exercised, which is suitable for the lack of leg muscle strength, or for strengthening the muscle strength training mode.



**PROGRAM 15, Downhill training mode :**

The principle of running downhill is to rely on external forces, gravity acceleration running downwards, and long-term practice to achieve the purpose of increasing running speed.

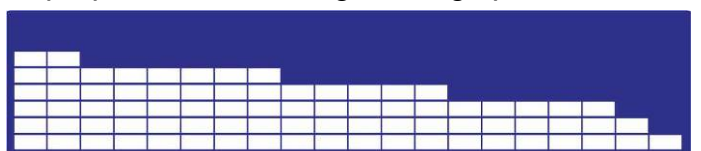
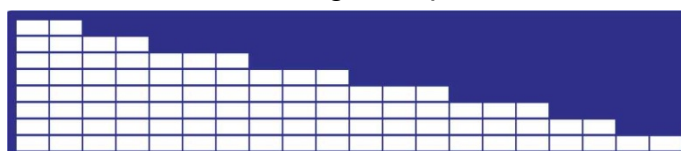

**PROGRAM 16, Cross-training :**

The balanced muscle training model is a kind of training constructed by a variety of movements. Systemic development does not limit special parts or energy systems, which is highly beneficial to the development of comprehensive physical fitness.



**PROGRAM 17, Downhill special training :**

Different grades can help exercise the calf, thigh, and buttock muscles. It is suitable for leg strength training.



**PROGRAM 18, Explosive sweating training mode :**

Use your best efforts to achieve the effect of high-intensity aerobics and muscular strength training. In a short time, you can help your heart rate reach over 90%. At the same time, you can train aerobic and muscular strength to generate afterburn, Helps burn calories, subtracts fat, retains or increases muscles, combined with the concept of aerobics and strength training.

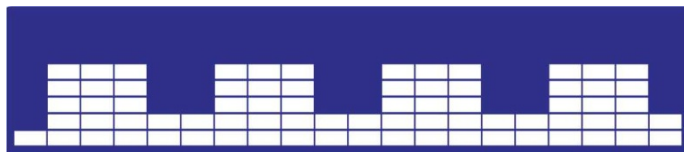

**FAT BURN :**

The Fat Burn program is designed, as the name implies, to maximize the burning of fat. There are many schools of thought on the best way to burn fat but most experts agree that a lower exertion level that stays at a steady workload is the best. The absolute best way to burn fat is to keep your heart rate at around 60% to 70% of its maximum potential. This program does not use heart rate but simulates a lower, steady exertion workout.

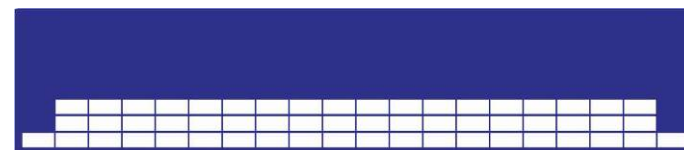
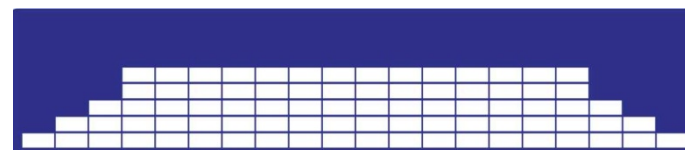

**CARDIO :**

The Cardio program is designed to increase your cardiovascular function and endurance. This is exercise for your heart and lungs. It will build up your heart muscle and increase blood flow and lung capacity. This is achieved by incorporating a higher level of exertion with slight fluctuations in work.



**HILL :**

The Hill program simulates going up and down a hill. The resistance in the pedals will steadily increase and then decrease during the program.

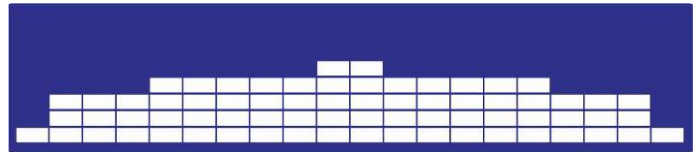
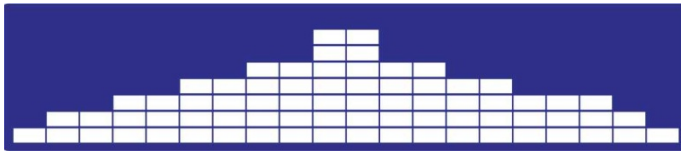

**INTERVAL :**

The Interval program takes you through high levels of intensity followed by periods of low intensity. This program increases your endurance by depleting your oxygen level followed by periods of recovery to replenish oxygen. Your cardiovascular system gets programmed to use oxygen more efficiently this way. This program also forces your body to become more efficient due to spikes in heart rate, between recovery periods. This aids in heart rate recovery from intense activities.

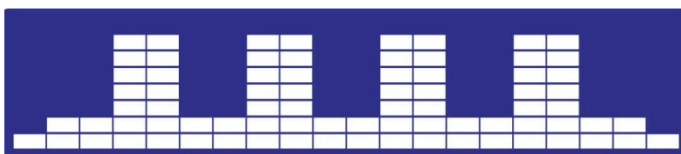

# Using A Heart Rate Transmitter

How to wear your wireless chest strap transmitter:

1. Attach the transmitter to the elastic strap using the locking parts.
2. Adjust the strap as tightly as possible as long as the strap is not too tight to remain comfortable.
3. Position the transmitter with the logo centered in the middle of your body facing away from your chest (some people must position the transmitter slightly left of center). Attach the final end of the elastic strap by inserting the round end and, using the locking parts, secure the transmitter and strap around your chest.
4. Position the transmitter immediately below the pectoral muscles.
5. Sweat is the best conductor to measure very minute heart beat electrical signals. However, plain water can also be used to pre-wet the electrodes (2 ribbed oval areas on the reverse side of the belt and both sides of the transmitter). It's also recommended that you wear the transmitter strap a few minutes before your work out. Some users, because of body chemistry, have a more difficult time in achieving a strong, steady signal at the beginning. After "warming up", this problem lessens. As noted, wearing clothing over the transmitter/strap doesn't affect performance.
6. Your workout must be within range - distance between transmitter/receiver – to achieve a strong steady signal. The length of range may vary somewhat but generally stay close enough to the console to maintain good, strong, reliable readings. Wearing the transmitter immediately against bare skin assures you of proper operation. If you wish, you may wear the transmitter over a shirt. To do so, moisten the areas of the shirt that the electrodes will rest upon.



*Note: The transmitter is automatically activated when it detects activity from the user's heart. Additionally, it automatically deactivates when it does not receive any activity. Although the transmitter is water resistant, moisture can have the effect of creating false signals, so you should take precautions to completely dry the transmitter after use to prolong battery life (estimated transmitter battery life is 2500 hours). The replacement battery is Panasonic CR2032.*

## Erratic Operation

**Caution!** Do not use this elliptical for Heart Rate Control unless a steady, solid Actual Heart Rate value is being displayed. High, wild, random numbers being displayed indicate a problem. Areas to look for interference which may cause erratic heart rate:

1. Microwave ovens, TV's, small appliances, etc.
2. Fluorescent lights.
3. Some household security systems.
4. Perimeter fence for a pet.
5. Some people have problems with the transmitter picking up a signal from their skin. If you have problems try wearing the transmitter upside down. Normally the transmitter will be oriented so the logo is right side up.
6. The antenna that picks up your heart rate is very sensitive. If there is an outside noise source, turning the whole machine 90 degrees may de-tune the interference.
7. Another Individual wearing a transmitter within 3' of your machine's console.

If you continue to experience problems contact your dealer.

# General Maintenance

1. Wipe down all areas in the sweat path with a damp cloth after each workout.
2. If a squeak, thump, clicking or rough feeling develops, the main cause is most likely one of two reasons:
  - i. The hardware was not sufficiently tightened during assembly. All bolts that were installed during assembly need to be tightened as much as possible. It may be necessary to use a larger wrench than the one provided if you cannot tighten the bolts sufficiently. The majority of calls to the service department for noise issues can be traced to loose hardware or the rear rails being dirty.
  - ii. Dirt build-up on the rear rails and polyurethane wheels are also a source of noise. Noise from build-up on the rails can cause a thumping sound that you would swear is coming from inside the main body of the machine because noise travels and is amplified in the tubing of the frame. Clean the rails and wheels with a lint free cloth and rubbing alcohol. Stubborn build-up can be removed with your thumbnail or a nonmetallic scraper, like the back edge of a plastic knife. After cleaning, apply a small amount of lubricant on the rails with your fingers or a lint free cloth. You only need a thin coat of lubrication, wipe off any excess.
3. If squeaks or other noises persist, check that the unit is properly leveled before calling the service department.

## Elliptical Noises

Your new elliptical is engineered and manufactured to the strictest industry standards and tolerances. All elliptical trainers, no matter who the manufacturer, have a multitude of moving linkages and parts. Be aware that even with the tightest mechanical tolerances there still could be a slight amount of play between some parts. This inherent play can result in slight noises during use such as clicks and small thumps. Please expect that the elliptical will not be completely silent.

# Exploded View Diagram

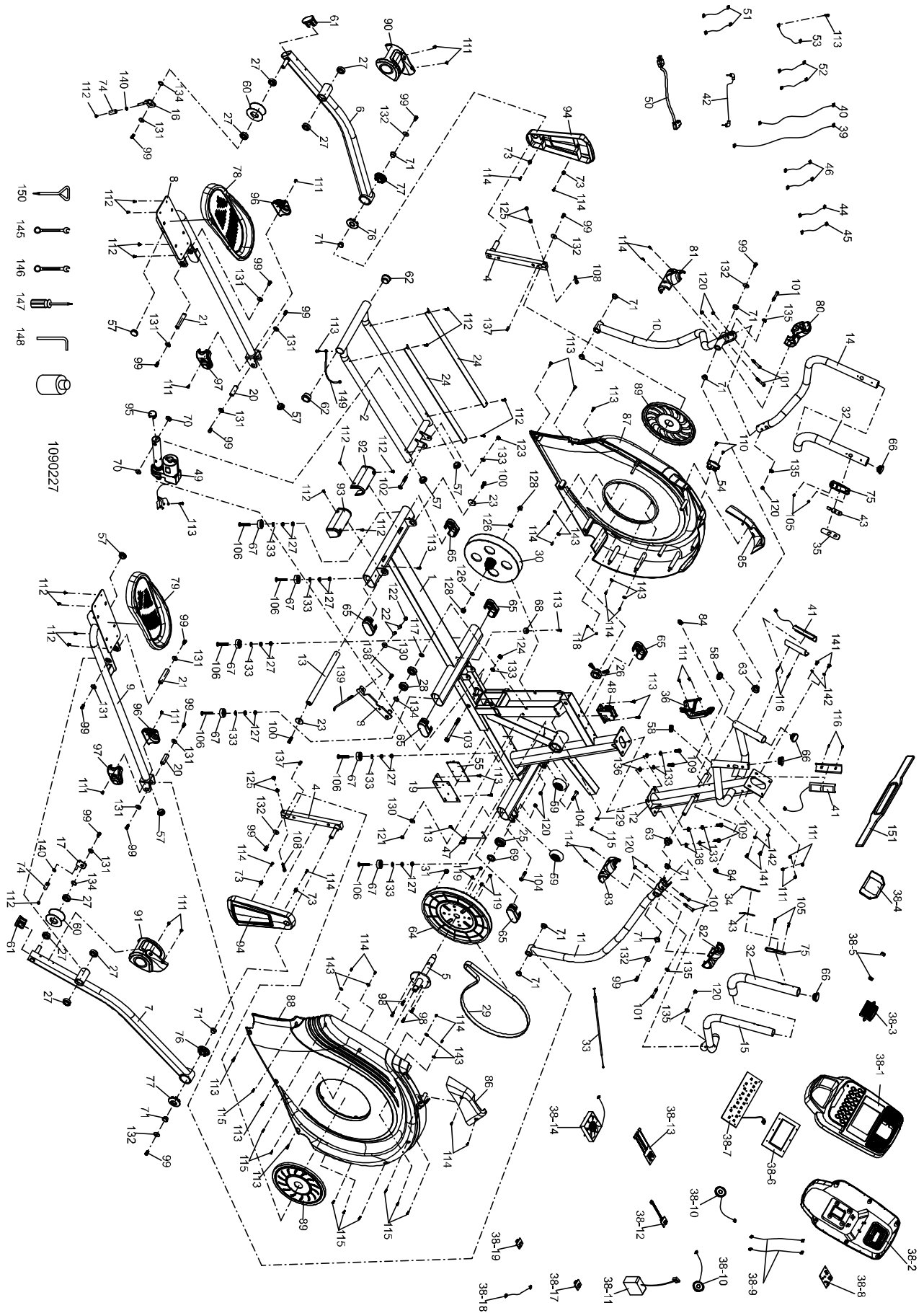

# Parts List

KEY NO.	PART NO.	Description	Q'TY
1	BB010097-Q2	Main Frame	1
2	BB030068-Q2	Rear Rail Assembly	1
3	RC145001-Q2-01	Idler Wheel Assembly	1
4	BB040033-Q2	Crank Arm Assembly	2
5	RC140041	Bushing Housing, Pedal Arm	1
6	RBB050262-Q2-01	Pedal Arm (L)	1
7	RBB050263-Q2-01	Pedal Arm (R)	1
8	BB050264-Q2	Connecting Arm (L)	1
9	BB050265-Q2	Connecting Arm (R)	1
10	BB060169-Q2	Lower Handlebar (L)	1
11	BB060170-Q2	Lower Handlebar (R)	1
12	BB020112-Q2	Console Mast	1
13	BB070105	Locking Tube Assembly	1
14	RA040454-Q2-02	Left Handlebar (Top)	1
15	RA040456-Q2-02	Right Handlebar (Top)	1
16	BB070106-Q2	Left Anti-Off Assembly	1
17	BB070107-Q2	Right Anti-Off Assembly	1
19	B060097-Q2	Controller Back Plate	1
20	C050079-Z4	Axle	2
21	C060027-Z4	Axle for Pedal	2
22	C080008-Z1	Rod End Sleeve	2
23	B020188-T33	Ø38 × Ø8.5 × 4T Flat Washer	2
24	M030024-Z0	Aluminum Rail	2
25	K056005	6005_Bearing	1
26	K056005D	6005-2RS/B10+2M5_Bearing	1
27	K056003	6003_Bearing	8
28	K056203	6203_Bearing	2
29	N010002C	Drive Belt	1
30	K500042	Flywheel	1
31	N040002	Magnet	1
32	L120002-A1	Handgrip Foam	2
33	K020046	Steel Cable	1
34	I080497-B1	Handgrip Resistance Label (LEVEL)	1
35	I080497-B2	Handgrip Resistance Label (INCLINE)	1
36	N240001	Drink Bottle Holder	1
38	RZ5GE004B-20	Console Assembly	1
39	E020100	1600m/m_12P Computer Cable	1
40	E020710-02	800m/m_5P Computer Cable	1
41	F090204	850m/m_Handpulse Assembly	2
42	E090001	400m/m_Audio Cable	1
43	F090401	Resistance Button W/Cable	2
44	E050101	450m/m_Handle Wire (Upper), Resistance (White)	1
45	E050102	450m/m_Handle Wire (Upper), Incline (Red)	1
46	E050104	900m/m_Switch Cable (Lower), Resistance/Incline	2
47	F030403-01	700m/m_Sensor W/Cable	1
48	F090320	Gear Motor	1
49	G120102	Incline Motor	1



KEY NO.	PART NO.	Description	Q'TY
50	E060001	Power Cord	1
51	E010064	400m/m_Connecting Wire, Controller	2
52	E010083	80m/m_Connecting Wire	2
53	E040007-01	200m/m_Ground Wire	1
54	F030053	AC Electronic Module	1
55	RD030251	Incline Controller	1
57	P040050-A1	Ø32(2.5T)_Round Cap	6
58	P040052-A1	Ø32(2.0T)_Round Cap	2
59	P050021-A1	Ø65_Transportation Wheel	2
60	RP050055-EQ-A	Ø78_Slide Wheel , Urethane	2
61	P040172-A1	Stabilizer End Cap	2
62	P060029-A1	Bushing	2
63	P060056-A1	Upright Bar Bushing	2
64	PP060090-A1-B	Drive Pulley	1
65	PP040212-A1	Oval End Cap	6
66	P060253-A1	Ø32 (1.8T)_Button Head Plug	4
67	P060256-A1	Ø35 × 10_Rubber Foot	6
68	P060264-A1	Rubber Foot Pad	1
69	P060273-A1	Spacer Bushing	1
70	P060221-A1	Ø25 × Ø10 × 3T_Nylon Washer	2
71	P060440	Bushing (WFM-1719-12)	12
73	P060549	End Cap Stopper	4
74	P060633B-A1	Sleeve	2
75	P160002-A1	Handle Switch Bracket	2
76	P270042	Bushing (Ø56×Ø19×15L(Flat))	2
77	P270043-Q81	Bushing (Ø56×Ø19×21L(Curved))	2
78	PP130015B-A1	Pedal (L)	1
79	PP130016B-A1	Pedal (R)	1
80	P180104-A1	Front Handle Cover (L)	1
81	P180105-A1	Rear Handle Cover (L)	1
82	P180106-A1	Front Handle Cover (R)	1
83	P180107-A1	Rear Handle Cover (R)	1
84	P040036-A1	Switch Wire Cap	2
85	PP100280-A1	Left Upright Cover	1
86	PP100281-A1	Right Upright Cover	1
87	RPP100282A-A1	Side Case (L)	1
88	RPP100283-A1	Side Case (R)	1
89	PP100283-A1	Side Case Pad	2
90	PP100284-Q7	Slide Wheel Cover (L)	1
91	PP200024-A1	Slide Wheel Cover (R)	1
92	PP200025-A1	Rear Slide Wheel Cover (L)	1
93	PP190068-A1	Rear Slide Wheel Cover (R)	1
94	PP190069-A1	Crank Arm End Cap	2
95	P180108C-A1	Round Cap	1
96	PP040213-A1	Connecting Arm Cover (L)	2
97	PP180168-A1	Connecting Arm Cover (R)	2
98	PP180169-A1	1/4" × 3/4" _Hex Head Bolt	4
99	J010002-ZZ	5/16" × 15m/m _Hex Head Bolt	16
100	J010520-YQ	5/16" × 1" _Hex Head Bolt	2
101	J010504-YV	5/16" × 1-3/4" _Hex Head Bolt	6

KEY NO.	PART NO.	Description	Q'TY
102	J011010R-YD	3/8" × 2-1/2" Hex Head Bolt	1
103	J013513L-Y1	M10 × 130m/m Hex Head Bolt	1
104	J020507AB-Y3	5/16" × 1-3/4" Button Head Socket Bolt	2
105	J552004-Z1	M5 × 20m/m Flat Head Socket Screw	4
106	J341008-Y3	3/8" × 2" Flat Head Socket Bolt	6
108	J033007-Z4	M8 × 35m/m Socket Head Cap Bolt	2
109	J031002-Z4	3/8" × 3/4" Socket Head Cap Bolt	4
110	J094502-Y3	M4 × 12m/m Phillips Head Screw	2
111	J092001-Y3	M5 × 10m/m Phillips Head Screw	14
112	J092001-YN	M5 × 10m/m Phillips Head Screw	18
113	J367114-Y3	5 × 19m/m Tapping Screw	16
114	J396804-Y3	Ø3.5 × 12m/m Sheet Metal Screw	18
115	J396805-Y3	Ø3.5 × 16m/m Sheet Metal Screw	10
116	J517007-Y3	Ø3 × 20m/m Tapping Screw	4
117	J310002-Z4	Ø17 C Ring	1
118	J139411-Y3	M4 × 5T Nylon Nut	2
119	J139461-Z1	1/4" Nylon Nut	4
120	J139062-Y3	5/16" × 7T Nylon Nut	8
121	J139261-ZF	M8 × 7T Nylon Nut	1
122	J139262-Y3	M8 × 9T Nylon Nut	1
123	J139011-Y3	3/8" × 7T Nylon Nut	1
124	J139361-Y3	M10 × 8T Nylon Nut	1
125	J129272-ZS	M8 × 6.3T Nut	4
126	J129031-Z1	3/8" × UNF26 × 4T Nut	2
127	J129021-Y3	3/8" × 7T Nut	12
128	J160028-Z1	3/8" × UNF26 × 11T Nut	2
129	J210012-Y3	Ø1/4" × 19 Flat Washer	1
130	J210009-Y3	5/16" × 23 × 1.5T Flat Washer	2
131	J210090-Y3	5/16" × 23 × 3.0T Flat Washer	10
132	J210042-Y3	Ø8.5 × 26 × 2.0T Flat Washer	6
133	J210003-Y3	3/8" × 19 × 1.5T Flat Washer	12
134	J210011-Z1	Ø17 × 23.5 × 1T Flat Washer	3
135	J220003-Y3	5/16" × 19 × 1.5T Curved Washer	4
136	J260003-Y3	3/8" × 2T Spring Washer	4
137	J320012-ZF	Woodruff Key	2
138	J073004-Z4	M8 × 20m/m Carriage Bolt	1
139	J080071M-Z1	M8 × 155m/m J Bolt	1
140	J590003-Z4	E-Clip	2
141	J092503-Y3	M6 × 15m/m Phillips Head Screw	4
142	J210048-Y3	Ø6.6 × 12 × 1.5T Flat Washer	4
143	J210086-Z1	Ø5 × 15 × 1.2T Flat Washer	8
145	J330025-Z1	13/14m/m Wrench	1
146	J330026-Z1	12/14m/m Wrench	1
147	J330008-Z1	Phillips Head Screwdriver	1
148	J330012-Z1	L Allen Wrench	1
149	E040060	Ground Wire	1
150	J330007-Z1	Short Phillips Head Screwdriver	1
151	F090001-A1-A1	Chest Strap (Optional)	1

# USER DIRECTION

## **IMPORTANT**

The elliptical comes with two Dual Action Handles and a Stationary Handlebar. Always hold the Stationary Handlebar when getting on and off the elliptical.

First time users should familiarize themselves with using the elliptical by using the Stationary Handlebar first and then progressing to the Dual Action Handles.

Once you have familiarized yourself with using the elliptical, you can progress to using the Dual Action Handles to provide a total body workout. Hands can be positioned on the Dual Action Handles at the most appropriate position for your height and arm length.

Caution should always be taken when getting on and off any exercise machine.

Please follow the safety steps below.

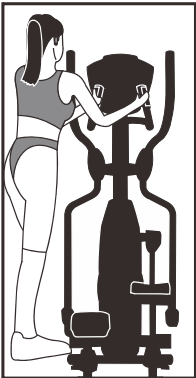

Ensure the left Foot Pedal is in the lowest position and grasp the Stationary Handlebar with both hands.

Place your left foot on the left Foot Pedal and get secure.

Lift your right foot over machine and place on right Foot Pedal. Get balanced and begin your workout.

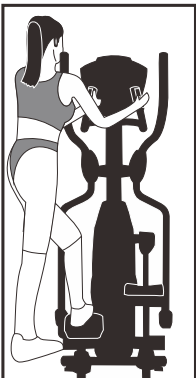

### **Important**

To get off, come to a complete stop and reverse the procedure. Always wear rubber-soled shoes, such as tennis shoes.

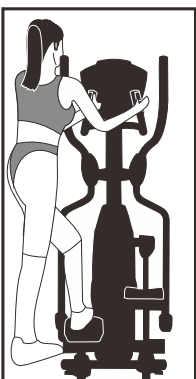

It is recommended that you keep at least one hand on the Stationary Handlebar at all times, especially when getting on or off. If you are performing a walking action with your arms, or doing upper body strength training exercises, ensure you are well balanced.

All equipment should be set-up and operated on solid, level surfaces.

## **Correct Position**



Your body should be in an upright position so that your back is straight. Keep your head up to minimize neck and upper back strain.

Always try and use the elliptical in a rhythmical and smooth motion. If you find yourself feeling uncomfortable, or experience a surging type feeling, there is probably too much tension.

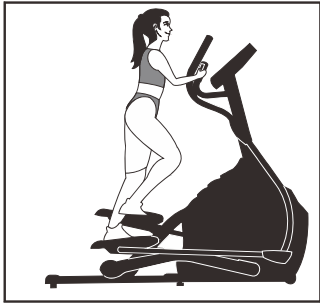

The elliptical can be used in forward or reverse motion.



When going in reverse, bend your knees slightly more. More emphasis is on the buttocks and hamstrings in the reverse motion.

## **MOVING YOUR ELLIPTICAL**

The elliptical can be easily moved from room to room.

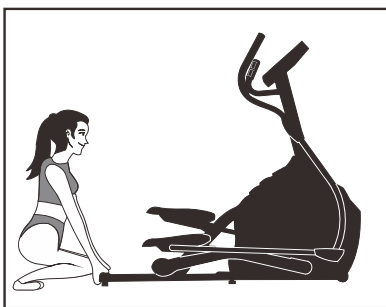

1. Move to the front of the machine and ensure swing arms are even (one foot pedal at top of Elliptical Disk and other at bottom).

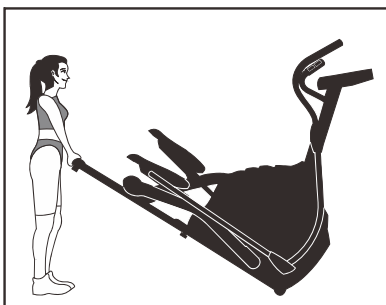

2. Grasp both Dual Action Handles together and pulling back on handles, tip machine towards you.

# TRAINING GUIDELINES

## EXERCISE

Exercise is one of the most important factors in the overall health of an individual. Listed among its benefits are:

- Increased capacity for physical work (strength endurance)
- Increased cardiovascular (heart and arteries/veins) and respiratory efficiency
- Decreased risk of coronary heart disease
- Changes in body metabolism, e.g. losing weight
- Delaying the physiological effects of age
- Physiological effects, e.g. reduction in stress, increase in self-confidence, etc.

## Basic Components of Physical Fitness

There are four all encompassing components of physical fitness and we need to briefly define each and clarify its role.

**Strength** is the capacity of a muscle to exert a force against resistance. Strength contributes to power and speed and is of great importance to a majority of sports people.

**Muscular Endurance** is the capacity to exert a force repeatedly over a period of time, e.g. it is the capacity of your legs to carry you 10 Km without stopping.

**Flexibility** is the range of motion about a joint. Improving flexibility involves the stretching of muscles and tendons to maintain or increase suppleness, and provides increased resistance to muscle injury or soreness.

**Cardio-Respiratory Endurance** is the most essential component of physical fitness. It is the efficient functioning of the heart and lungs

## Aerobic Fitness

The largest amount of oxygen that you can use per minute during exercise is called your maximum oxygen uptake (MVo<sub>2</sub>). This is often referred to as your aerobic capacity.

The effort that you can exert over a prolonged period of time is limited by your ability to deliver oxygen to the working muscles. Regular vigorous exercise produces a training effect that can increase your aerobic capacity by as much as 20 to 30%. An increased MVO<sub>2</sub> indicates an increased ability of the heart to pump blood, of the lungs to ventilate oxygen and of the muscles to take up oxygen.

## Anaerobic Training

This means “without oxygen” and is the output of energy when the oxygen supply is insufficient to meet the body’s long term energy demands. (For example, 100 meter sprint).

## The Training Threshold

This is the minimum level of exercise which is required to produce significant improvements in any physical fitness parameter.

## Progression

As you become fitter, a higher intensity of exercise is required to create an overload and therefore provide continued improvement

## **Overload**

This is where you exercise at a level above that which can be carried out comfortably. The intensity, duration and frequency of exercise should be above the training threshold and should be gradually increased as the body adapts to the increasing demands. As your fitness level improves, so the training threshold should be raised. Working through your program and gradually increasing the overload factor is important.

## **Specificity**

Different forms of exercise produce different results. The type of exercise that is carried out is specific both to the muscle groups being used and to the energy source involved. There is little transfer of the effects of exercise, i.e. from strength training to cardiovascular fitness. That is why it is important to have an exercise program tailored to your specific needs.

## **Reversibility**

If you stop exercising or do not do your program often enough, you will lose the benefits you have gained. Regular workouts are the key to success.

## **WARM UP**

Every exercise program should start with a warm up where the body is prepared for the effort to come. It should be gentle and preferably use the muscles to be involved later. Stretching should be included in both your warm up and cool down, and should be performed after 3-5 minutes of low intensity aerobic activity or callisthenic type exercise.

## **Warm Down or Cool Down**

This involves a gradual decrease in the intensity of the exercise session. Following exercise, a large supply of blood remains in the working muscles. If it is not returned promptly to the central circulation, pooling of blood may occur in the muscles

## **HEART RATE**

As you exercise, so the rate at which your heart beat also increases. This is often used as a measure of the required intensity of exercise. You need to exercise hard enough to condition your circulatory system, and increase your pulse rate, but not enough to strain your heart.

Your initial level of fitness is important in developing an exercise program for you. If you are starting off, you can get a good training effect with a heart rate of 110-120 beats per minute (BPM). If you are fitter, you will need a higher threshold of stimulation.

To begin with, you should exercise at a level that elevates your heart rate to about 65 to 70% of your maximum. If you find this is too easy, you may want to increase it, but it is better to lean on the conservative side.

As a rule of thumb, the maximum heart rate is 220 minus your age. As you increase in age, so your heart, like other muscles, loses some of its efficiency. Some of its natural loss is won back as fitness improves.

The following table is a guide to those who are “starting fitness”.

Age	25	30	35	40	45	50	55	60	65
Target heart Rate									
10 Second Count	23	22	22	21	20	19	19	18	18
Beats per Minute	138	132	132	126	120	114	114	108	108

### Pulse Count

The pulse count (on your wrist or carotid artery in the neck, taken with two index fingers) is done for ten seconds, taken a few seconds after you stop exercising. This is for two reasons: (a) 10 seconds is long enough for accuracy, (b) the pulse count is to approximate your BPM rate at the time you are exercising. Since heart rate slows as you recover, a longer count isn't as accurate.

The target is not a magic number, but a general guide. If you're above average fitness, you may work quite comfortably a little above that suggested for your age group.

The following table is a guide to those who are keeping fit. Here we are working at about 80% of maximum.

Age	25	30	35	40	45	50	55	60	65
Target heart Rate									
10 Second Count	26	26	25	24	23	22	22	21	20
Beats per Minute	156	156	150	144	138	132	132	126	120

Don't push yourself too hard to reach the figures on this table. It can be very uncomfortable if you overdo it. Let it happen naturally as you work through your program. Remember, the target is a guide, not a rule, a little above or below is just fine.

Two final comments: (1) don't be concerned with day to day variations in your pulse rate, being under pressure or not enough sleep can affect it; (2) your pulse rate is a guide, don't become a slave to it.

## ENDURANCE CIRCUIT TRAINING

Cardiovascular endurance, muscle, strength, flexibility and coordination are all necessary for maximum fitness. The principle behind circuit training is to give a person all the essentials at one time by going through your exercise program moving as fast as possible between each exercise. This increases the heart rate and sustains it, which improves the fitness level. Do not introduce this circuit training effect until you have reached an advanced program stage.

### Body Building

Is often used synonymously with strength training. The fundamental principal here is OVERLOAD. Here, the muscle works against greater loads than usual. This can be done by increasing the load you are working against.



## **Patronization**

This is the term used to vary your exercise program for both physiological and psychological benefits. In your overall program, you should vary the workload, frequency and intensity. The body responds better to variety and so do you. In addition, when you feel yourself getting “stale”, bring in periods of lighter exercise to allow the body to recuperate and restore its reserves. You will enjoy your program more and feel better for it.

## **Muscle Soreness**

For the first week or so, this may be the only indication you have that you are on an exercise program. This, of course, does depend on your overall fitness level. A confirmation that you are on the correct program is a very slight soreness in most major muscle groups. This is quite normal and will disappear in a matter of days.

If you experience major discomfort, you may be on a program that is too advanced or you have increased your program too rapidly.

If you experience PAIN during or after exercise, your body is telling you something. Stop exercising and consult your doctor.

## **WHAT TO WEAR**

Wear clothing that will not restrict your movement in any way while exercising. Clothes should be light enough to allow the body to cool. Excessive clothing that causes you to perspire more than you normally would while exercising, gives you no advantage. The extra weight you lose is body fluid and will be replaced with the next glass of water you drink. It is advisable to wear a pair of gym or running shoes or “sneakers”.

## **Breathing during Exercise**

Do not hold your breath while exercising. Breathe normally as much as possible. Remember, breathing involves the intake and distribution of oxygen, which feeds the working muscles.

## **Rest periods**

Once you start your exercise program, you should continue through to the end. Do not break off halfway through and then restart at the same place later on without going through the warm-up stage again.

The rest period required between strength training exercises may vary from person to person. This will depend mostly on your level of fitness and the program you have chosen. Rest between exercises by all means, but do not allow this to exceed two minutes. Most people manage with half minute to one minute rest periods

# STRETCHING

Stretching should be included in both your warm up and cool down, and should be performed after 3-5 minutes of low intensity aerobic activity or callisthenic type exercise. Movements should be performed slowly and smoothly, with no bouncing or jerking. Move into the stretch until slight tension, not pain, is felt in the muscle and hold for 20-30 seconds. Breathing should be slow, rhythmical and under control, making sure never to hold your breath.

## HEAD ROLLS

Rotate your head to the right for one count, feeling stretch up the left side of your neck. Next rotate head back for one count, stretching your chin to the ceiling and letting your mouth open. Rotate your head to the left for one count, and finally, drop your head to your chest for one count.

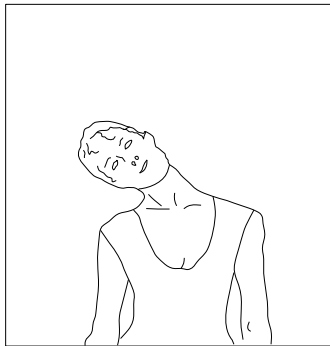

## SHOULDER LIFTS

Lift your right shoulder up toward your the ear for one count. Then lift your left your shoulder up for one count as you lower your right shoulder.

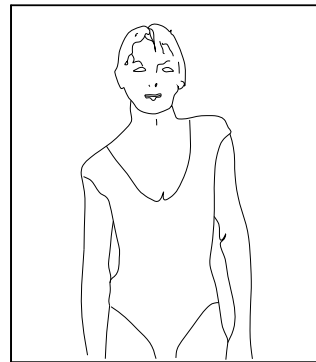

## SIDESTRETCHES

Open your arms to the side and continue lifting them until they are over your head. Reach your right arm as far upward toward the ceiling as you can for one count. Feel the stretch up your right side. Repeat this action with your left arm.

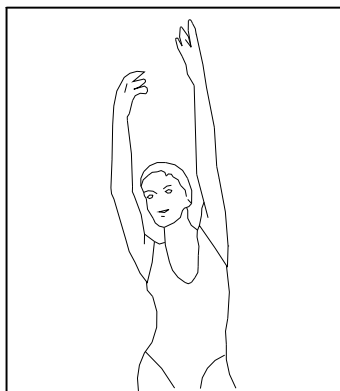

## QUADRICEPS STRETCH

With one hand against a wall for balance, reach behind you and pull your right foot up. Bring your heel as close to your buttocks as possible. Hold for 15 counts and repeat with left foot up.

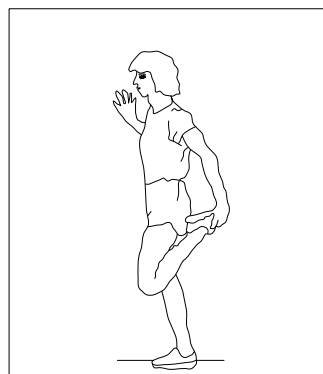

### **INNER THIGH STRETCH**

Sit with the soles of your feet together with your knees pointing outward. Pull your feet as close into your groin as possible. Gently push your knees towards the floor. Hold for 15 counts.

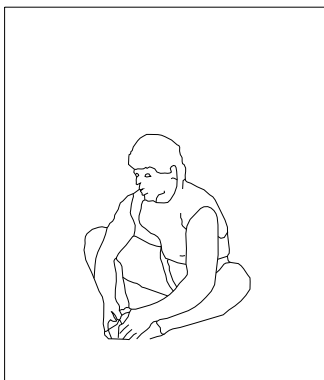

### **TOUCHES**

Slowly bend forward from your waist, letting your back and shoulders relax as you stretch toward your toes. Reach down as far as you can and hold for 15 counts.

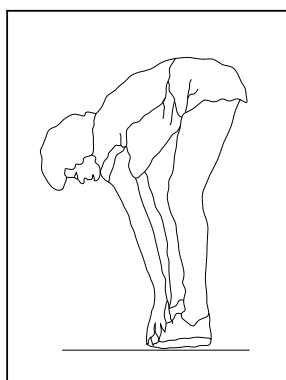

### **HAMSTRING STRETCHES**

Sit with your right leg extended. Rest the sole of your left foot against your right inner thigh. Stretch as far as possible. Hold for 15 counts. Relax and then repeat with left leg extended.

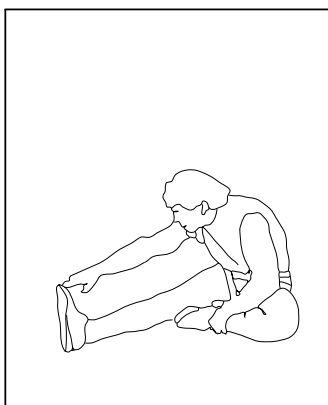

### **CALF / ACHILLES STRETCH**

Lean against a wall with your left leg in front of the right and your arms forward. Keep toward your toe your right leg straight and the left foot on the floor then bend the left leg and lean forward by moving your hips toward the wall. Hold, then repeat on the other side for 15 counts.

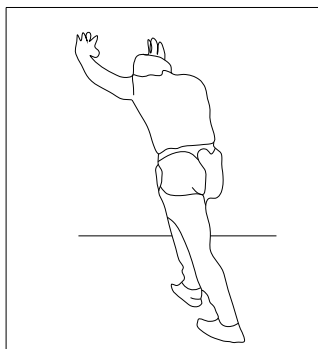

# dyaco

Please visit us online for information about our other brands and products manufactured and distributed by Dyaco Canada Inc.

**SPIRIT**

[spiritfitness.ca](http://spiritfitness.ca)

**X** XTEERRA

[xterrafitness.ca](http://xterrafitness.ca)

**UFC**

[dyaco.ca/UFC/UFC-home.html](http://dyaco.ca/UFC/UFC-home.html)

**SOLE**  
FITNESS

[solefitness.ca](http://solefitness.ca)

**EVERLAST**

[dyaco.ca/products/everlast.html](http://dyaco.ca/products/everlast.html)

 Johnny G  
by **SPIRIT**

[spiritfitness.ca/johnnyg.html](http://spiritfitness.ca/johnnyg.html)

**TRINOR**  
**SPORTS**

[trainorsports.ca](http://trainorsports.ca)

For more information, please contact Dyaco Canada Inc.

T: 1-888-707-1880 | 5955 Don Murie St., Niagara Falls, Ontario L2G 0A9 | [sales@dyaco.ca](mailto:sales@dyaco.ca)

Dyaco Canada Inc. [dyaco.ca](http://dyaco.ca)